

JBL

MultiMedia Series Loudspeakers

Media 2000 Media Sub2000

(230V)



From the world's premier movie houses, concert stages and recording studios
to a PC near you – legendary, high-performance
JBL sound that audio professionals have relied on for more than fifty years.

thank you for choosing JBL. For over 50 years, JBL has been involved in every aspect of musical and film recording and reproduction, from live performances to monitoring the recordings you play in your home, car or office.

We're confident that the **JBL loudspeaker** you have chosen will provide every note of enjoyment that you expected – and that when you think about purchasing additional audio equipment for your home, car or office, you will once again choose JBL.

Please take a moment to complete the enclosed profile card. It enables us to keep you posted on our latest advancements, and helps us to better understand our customers and build products that meet their needs and expectations.

JBL Consumer Products

Declaration of Conformity



Dir. 2011. 84. 84. 84. 84. 84.
Cm. 2011. 84. 84. 84. 84.
CE 2011. 84. 84. 84. 84.
CE 2011. 84. 84. 84. 84.

Declaring in full responsibility, that the products covered by
this declaration are in conformity with the following
standards:

- EN 12345 12345 6789
- EN 12345 12345 6789
- EN 12345 12345 6789
- EN 12345 12345 6789
- EN 12345 12345 6789

Ilse, Maria
Dir. 2011. 84. 84. 84. 84.
Date of 2011. 84. 84. 84. 84.

1. Placement

Media 2000

For optimum performance and stereo imaging, slightly angle the speakers toward the listening position.

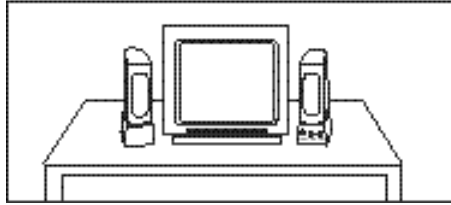

Media Sub2000

The Media Sub2000 can be placed on the desktop or

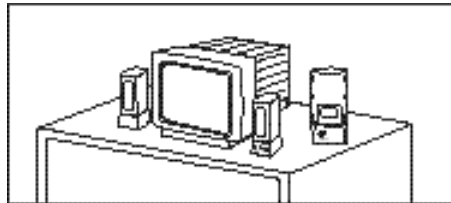

the floor.

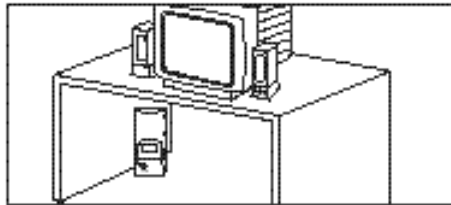

2. Connections

Media 2000 without subwoofer

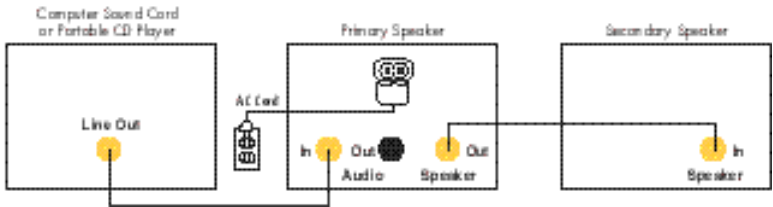

Media 2000 with Media Sub2000 subwoofer

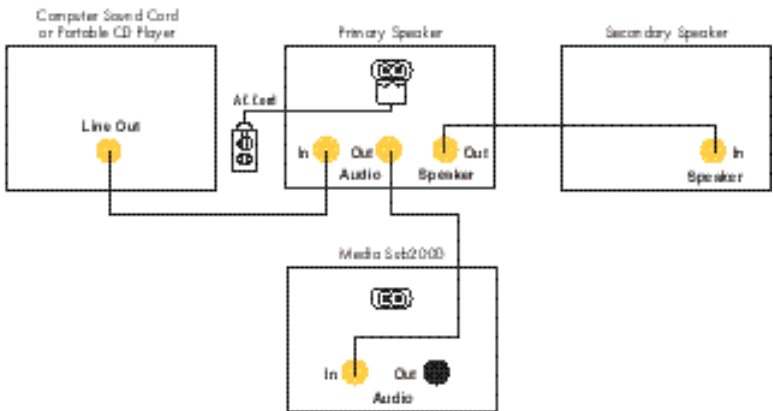

Media Sub2000 with existing satellite speakers

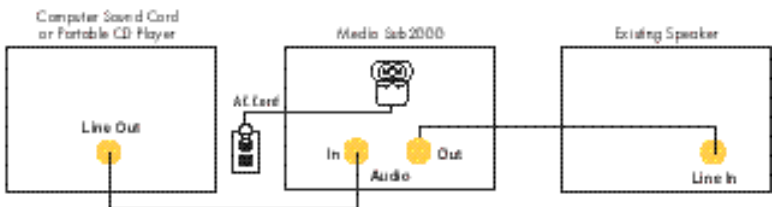

3. Operation

Media 2000

Volume:

To raise the volume level, rotate the *volume* knob clockwise.

To lower the volume level, rotate the *volume* knob counterclockwise.

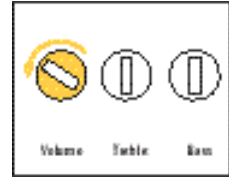

Treble:

To raise the treble level, rotate the *treble* knob clockwise.

To lower the treble level, rotate the *treble* knob counterclockwise.



Bass:

To raise the bass level, rotate the *bass* knob clockwise.

To lower the bass level, rotate the *bass* knob counterclockwise.



Multiposition directional adjustment

The Media 2000 speakers incorporate a multiposition directional adjustment that allows you to tilt the speakers toward the listening area. This allows you to position the speakers for ideal sound reproduction and imaging.

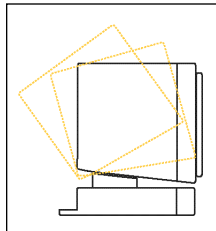

Media Sub2000

Level:

To raise the output level, rotate the *level* knob clockwise.

To lower the output level, rotate the *level* knob counterclockwise.



Auto turn-on/turn-off

The Media 2000 and Media Sub2000 feature an automatic turn-on/turn-off feature. They will turn off when the source equipment (computer or CDplayer) has no sound output for approximately fifteen minutes and immediately turn back on when a signal is present.

4. Specifications

Media 2000

- Maximum Amplifier Output:**
15 watts/channel @ 1% THD
- Frequency Response:**
70Hz – 20kHz
- Input Sensitivity:** 3V maximum
- Input Impedance:** 10k ohms
- Signal Input Jack:**
Stereo mini-connector (1/8")
- Subwoofer Output Jack:**
Stereo mini-connector (1/8")
- Dimensions (H x W x D):**
7-5/8 x 3 x 7-7/8"
194 x 76 x 200mm
- Weight:**
2 lbs./0.9 kg – main
1.5 lbs./0.7 kg – secondary

Media Sub2000

- Maximum Amplifier Output:**
35 watts @ 1% THD
- Frequency Response:**
50Hz – 120Hz
- Input Sensitivity:** 3V maximum
- Input Impedance:** 10k ohms
- Signal Input Jack:**
Stereo mini-connector (1/8")
- Subwoofer Output Jack:**
Stereo mini-connector (1/8")
- Dimensions (H x W x D):**
9-5/8 x 5-1/4 x 10-3/4"
244 x 133 x 273mm
- Weight:**
7 lbs./3.2 kg



JBL Consumer Products

80 Crossways Park West, Woodbury, NY 11797

8500 Balboa Boulevard, Northridge, CA 91329

© 1997 JBL, Incorporated. JBL is a registered trademark of JBL, Incorporated.

Printed 10/97  Part No. MED/MEDSUB2000OM230V

 A Harman International Company

